

DIRECCION DE PRESUPUESTO
79 M2

DIRECCION DE PRESUPUESTO
MOBILIARIO
BEDE MATRIZ PISO 8
ESC 1450



DIRECCION DE PRESUPUESTO

EOH	EOV	EOB	EEH	EOI	MCH	A11	CRH	SMH	MRC	AMH	AM2	TH	T2	CH
6			1		1	3	1	1		1	1			1

SALA OPERATIVA 5 SALA EJECUTIVA 1 SALAS 1 SALA GERENCIAL 1 SALA VISTA 4

[Handwritten signature]

[Handwritten signature]

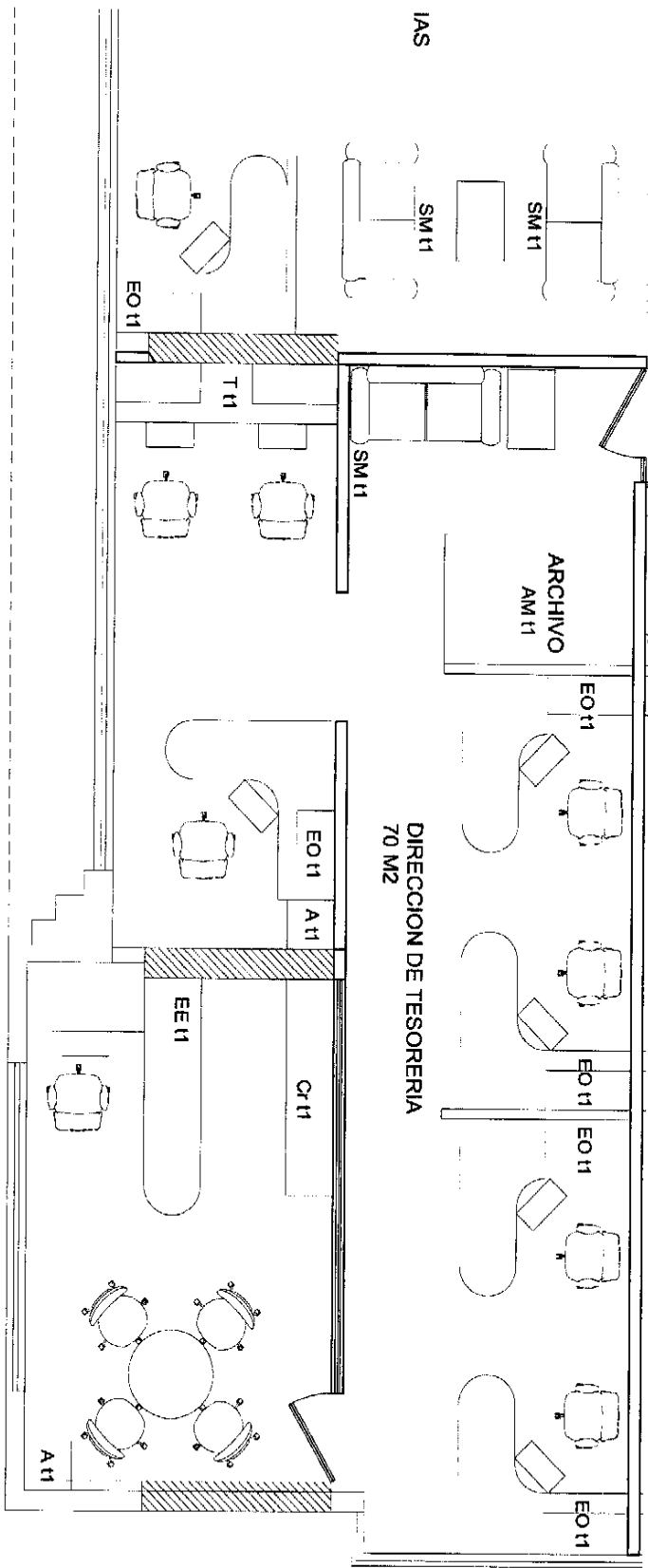

DIRECCION DETESORERIA
BEDE MATRIZ PISO 8
 ESC 156

DIRECCION DE TESORERIA									
EO 11	EO 12	EO 13	EO 14	EO 15	EO 16	EO 17	EO 18	EO 19	EO 20
5	-	-	1	-	-	-	2	-	-
SALA OPERATIVA									
SM 11	MRG	AMH	AMP	T 11	T 2	CH			
1	-	-	-	1	-	-			
SALA EJECUTIVA									
SM 11	MRG	AMH	AMP	T 11	T 2	CH			
1	-	-	-	1	-	-			
SALA GERENCIAL									
SM 11	MRG	AMH	AMP	T 11	T 2	CH			
1	-	-	-	1	-	-			
SALA VISITA									
SM 11	MRG	AMH	AMP	T 11	T 2	CH			
1	-	-	-	1	-	-			

Handwritten signatures and initials at the bottom right of the page.

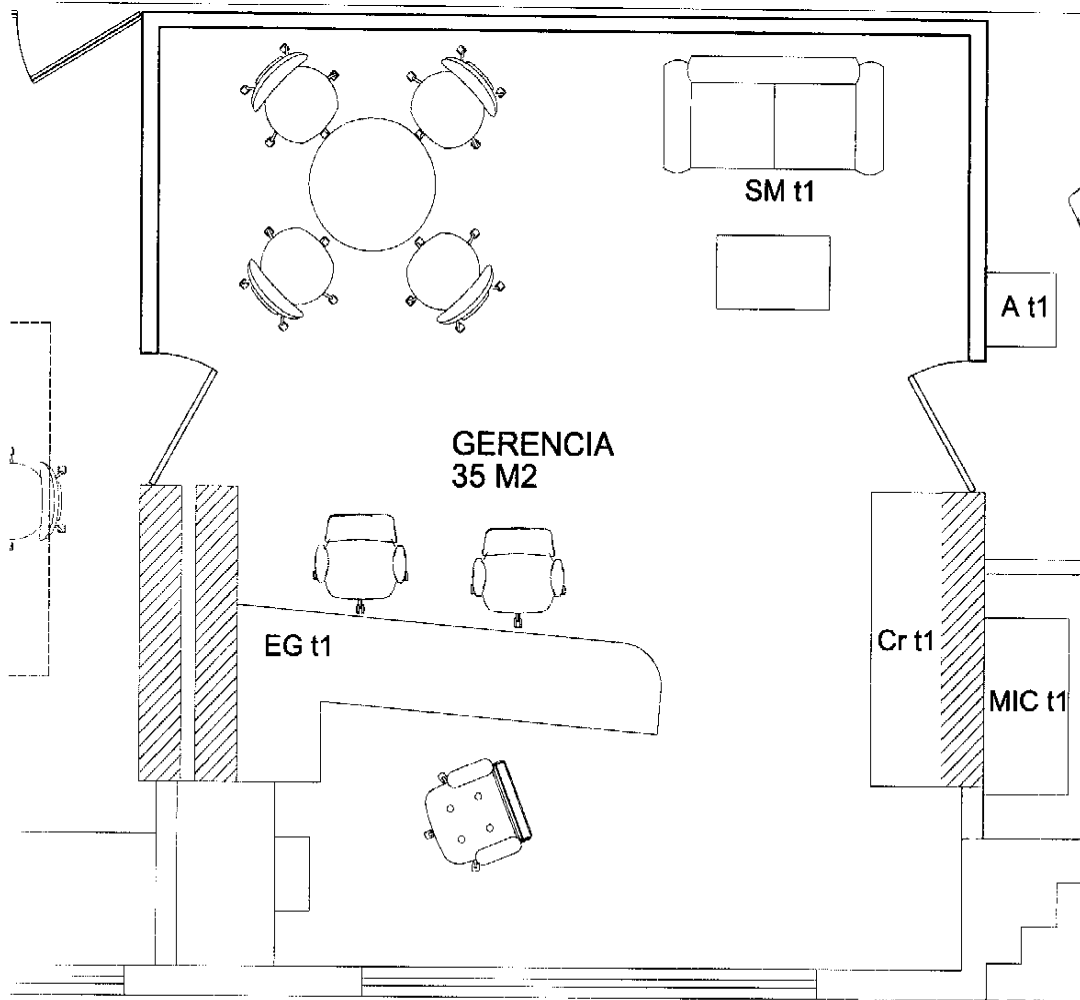

**GERENCIA MOBILIARIO
BEDE MATRIZ PISO 8**

ESC 1:50

GERENCIA FINANCIERA

EO t1	EO t2	EO t3	EE t1	EG t1	MCI t1	A t1	Cr t1	SM t1	MRG	AM t1	AM t2	T t1	T t2	C t1
-	-	-	-	1	-	-	1	1	-	-	-	-	-	-
SILLAS														
SILLA OPERATIVA			SILLA EJECUTIVA			SILLA GERENCIAL			SILLA VISITA					
-			-			-			1					
6														

FA

[Handwritten signature]

ESPECIFICACIONES

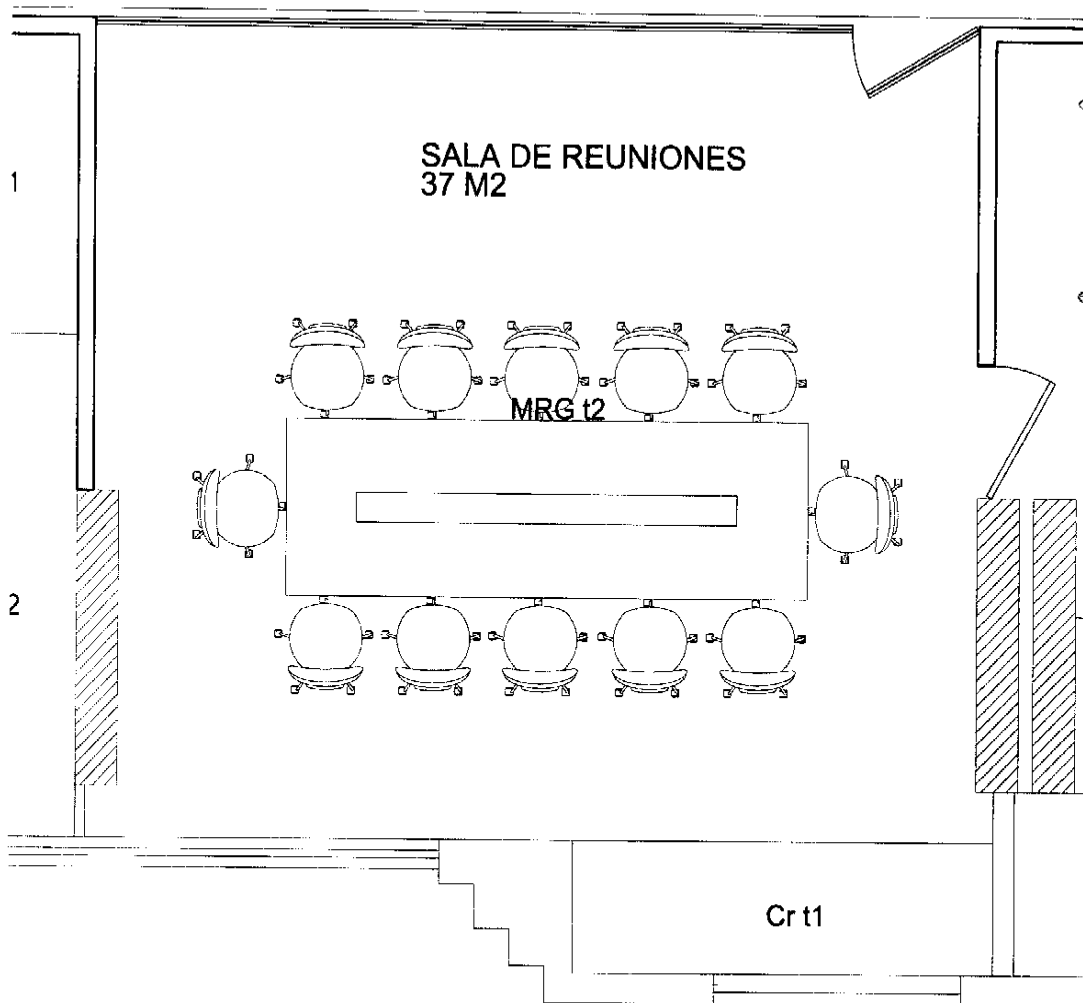

SALA DE REUNIONES MOBILIARIO
BEDE MATRIZ PISO 8

ESC 1:50

SALA DE REUNIONES

EO t1	EO t2	EO t3	EE t1	EG t1	MCI t1	A t1	Cr t1	SM t1	MRG	AM t1	AM t2	T t1	T t2	C t1
-	-	-	-	-	-	-	1	-	1	-	-	-	-	-
										SILLAS				
					SILLA OPERATIVA		SILLA EJECUTIVA		SILLA GERENCIAL		SILLA VISITA			
							12							

Handwritten initials

Handwritten signature

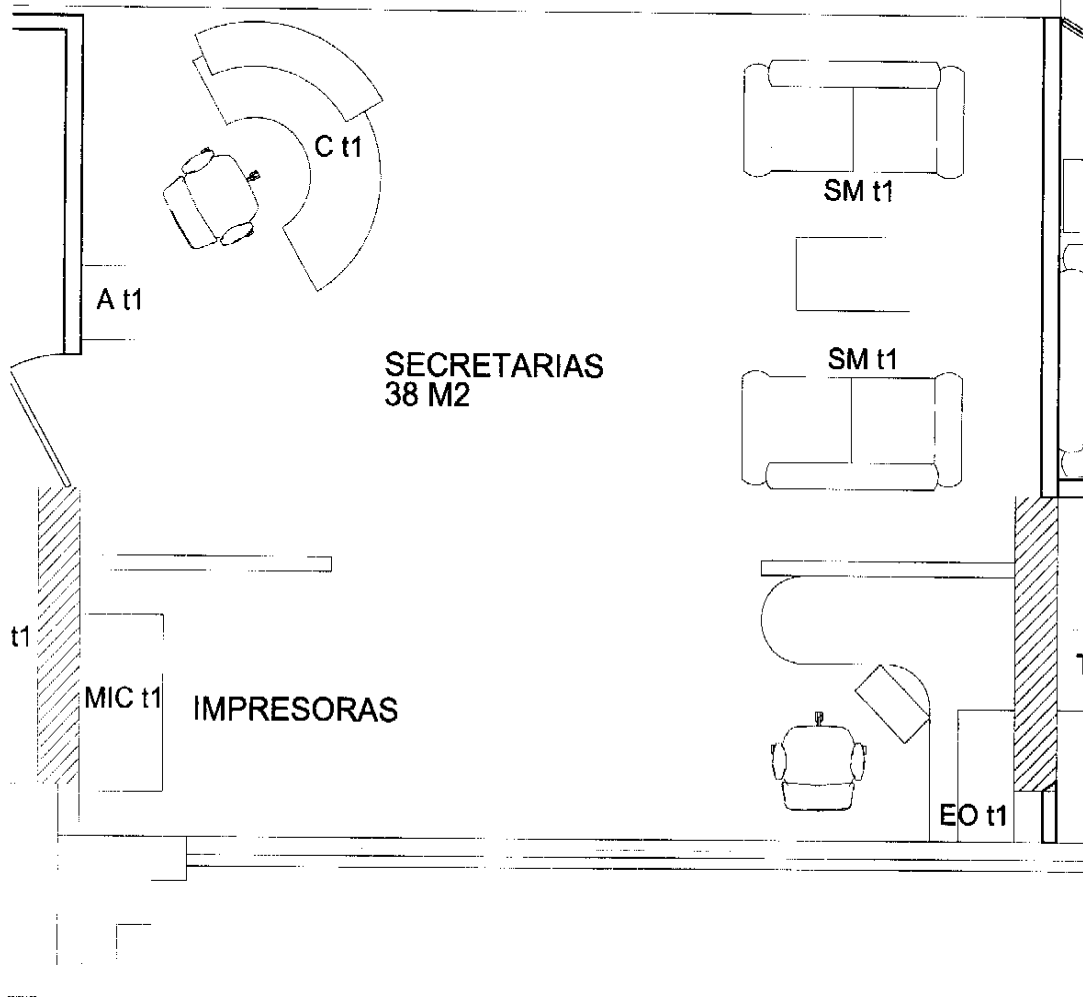

**SECRETARIAS MOBILIARIO
BEDE MATRIZ PISO 8**

ESC 1:50

PULL DE SECRETARIAS

EO t1	EO t2	EO t3	EE t1	EG t1	MCI t1	A t1	Cr t1	SM t1	MRG	AM t1	AM t2	T t1	T t2	C t1
1	-	-	-	-	1	1	-	2	-	-	-	-	-	1
SILLAS														
					SILLA OPERATIVA			SILLA EJECUTIVA			SILLA GERENCIAL			SILLA VISITA
					2									

FR

Handwritten signature and initials

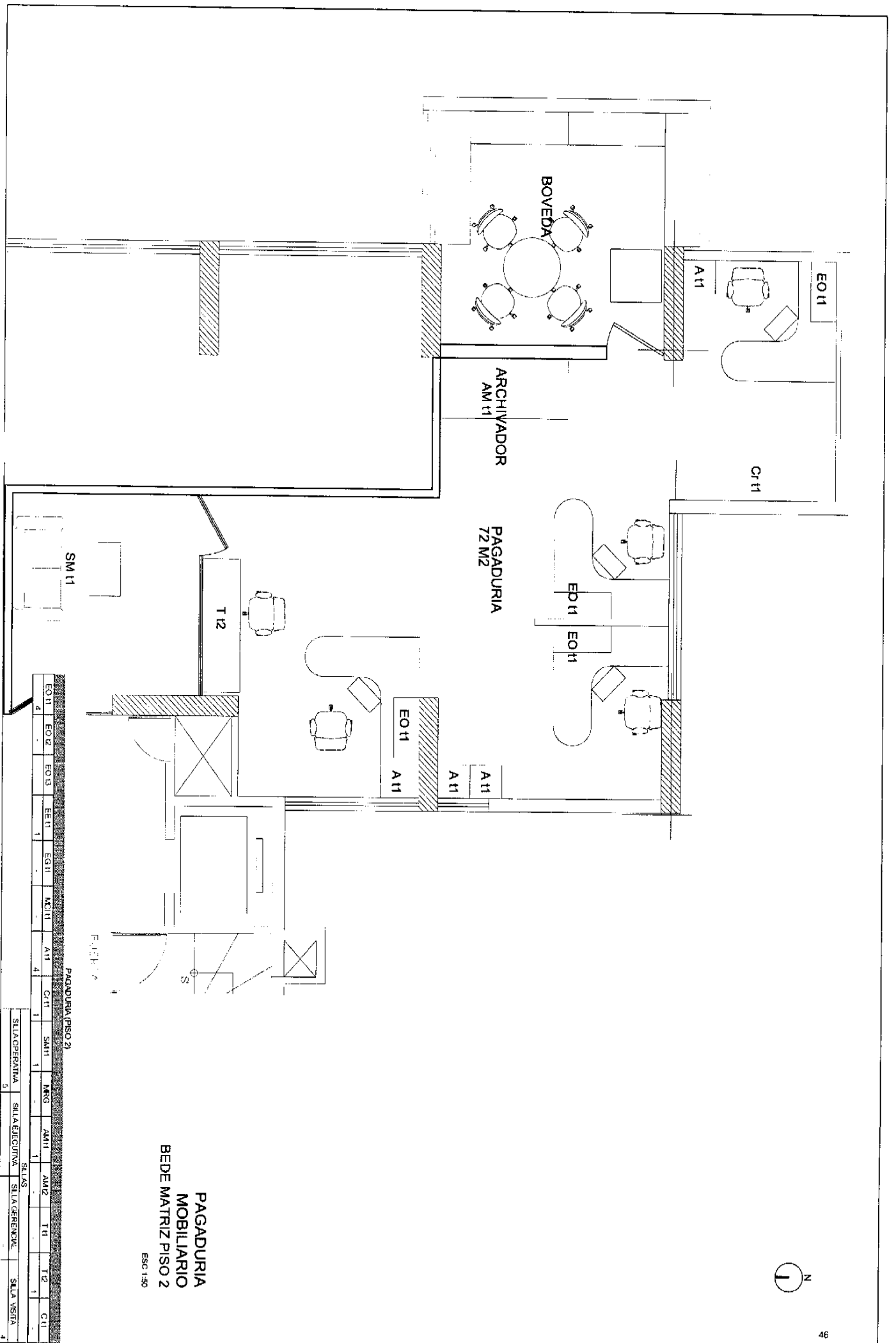

Handwritten signature and initials.

**PAGADURIA
MOBILIARIO
BEDE MATRIZ PISO 2**
ESC 1:50

PAGADURIA PISO 2											
EO 11	EO 2	EO 3	EO 4	EO 5	EO 6	EO 7	EO 8	EO 9	EO 10	EO 11	EO 12
4				1						4	
SALA OPERATIVA			SALA EJECUTIVA			SALAS			SALA VISITA		
3	1	1	1	1	1	1	1	1	1	1	1

Handwritten signature.

ESPECIFICACIONES

- ① Calcomera metálica
Terminado color aluminio
- ② Tablero de aglomerado e=2cm
Terminado de dos caras color aluminio
Terminado de canto duro color aluminio
- ③ Alidera
Color aluminio
- ④ Chapa de seguridad

PLANTA
ARCHIVADOR 4 GAVETAS
TIPO1
BEDE MATRIZ
ESC 1:10

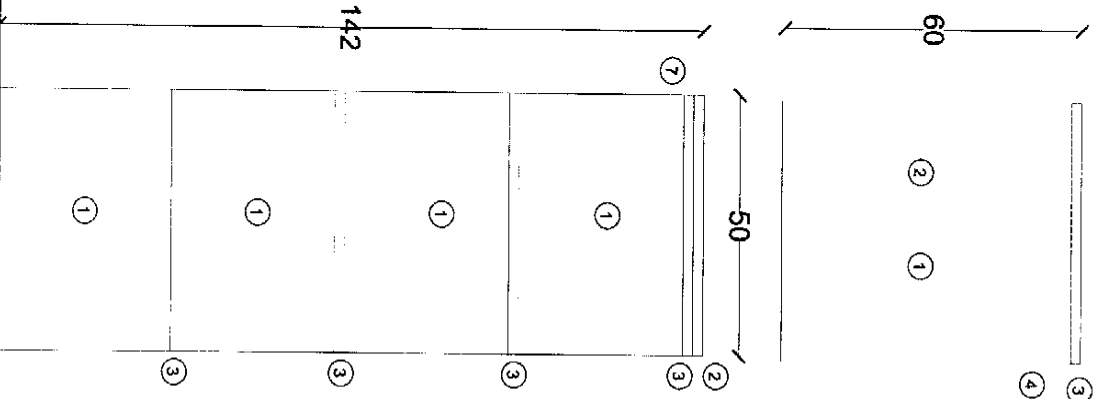

At1

AXONOMETRIA
ARCHIVADOR 4 GAVETAS
TIPO1
BEDE MATRIZ
ESC 1:10

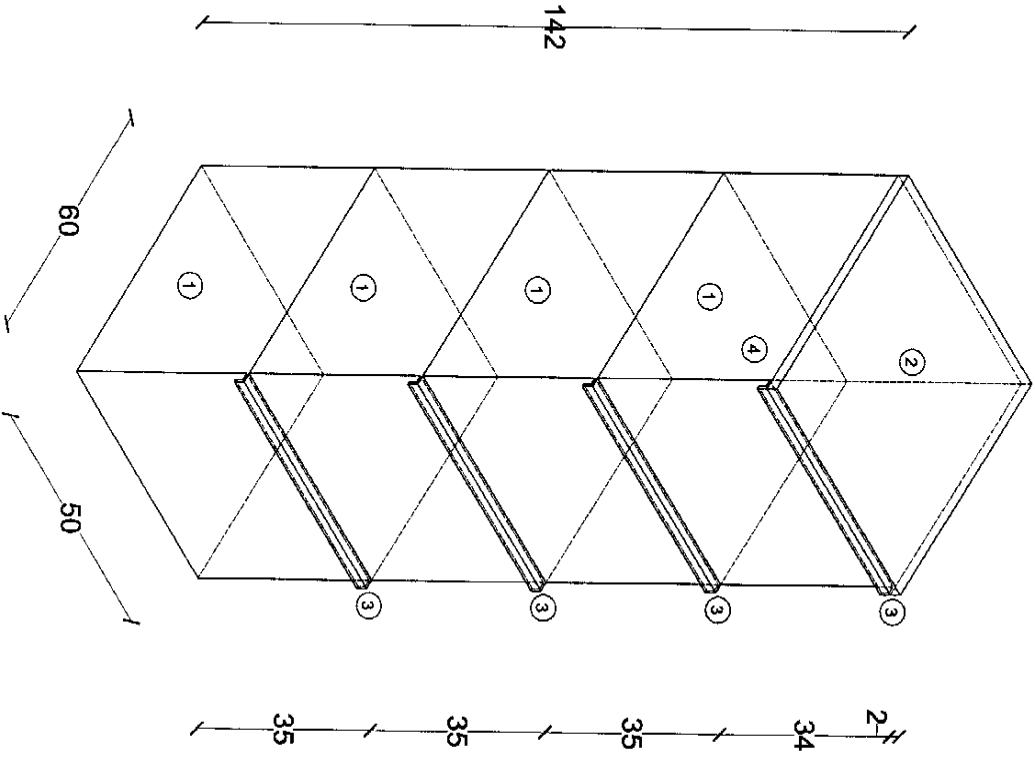

ELEVACION ARCHIVADOR 4 GAVETAS
TIPO1
BEDE MATRIZ
ESC 1:10

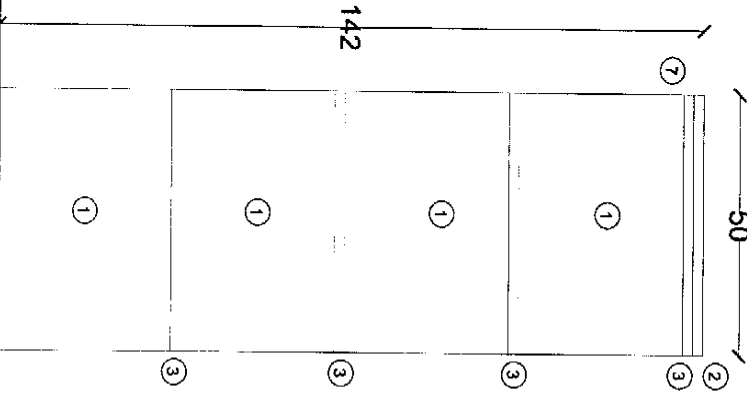

PROYECTO	
Reestructuración BEDE piso 8 y 2	
Departamento Financiero	
Proyectado	Programado
Proyectado	Programado
Proyectado	Programado

[Handwritten signature]

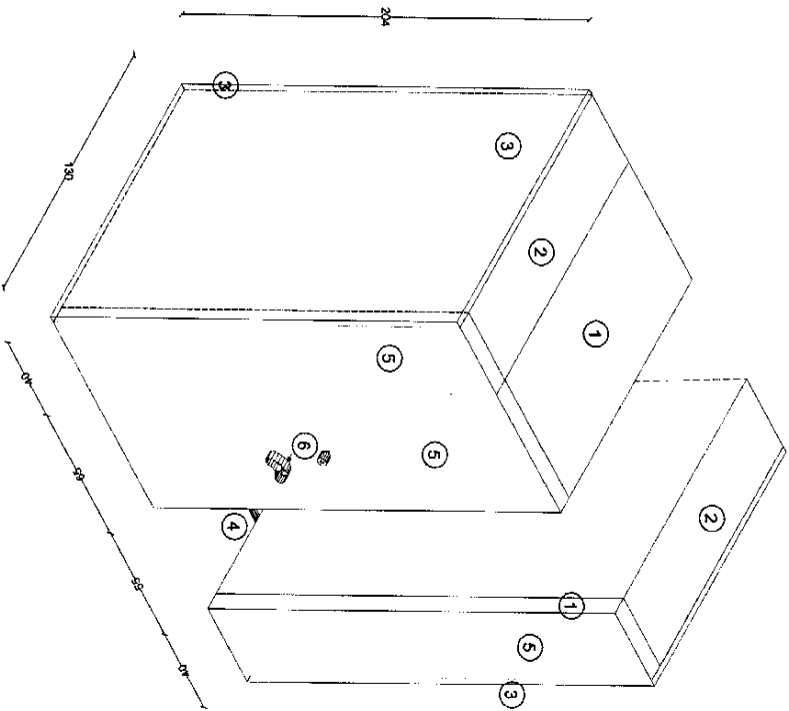

AXONOMETRIA
ARCHIVADOR MOVIL
TIPO2
BEDE MATRIZ

ESC 1 25

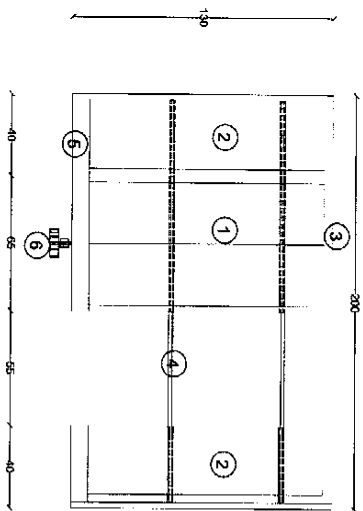

PLANTA ARCHIVADOR MOVIL
TIPO2
BEDE MATRIZ

ESC 1 25

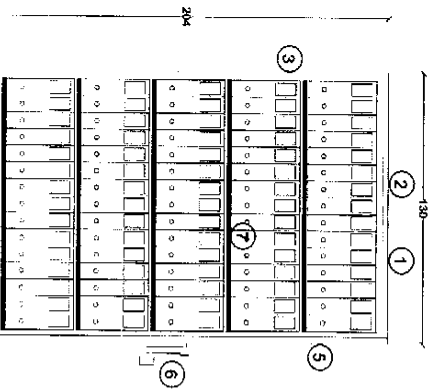

ELEVACION ARCHIVADOR MOVIL
TIPO2
BEDE MATRIZ

ESC 1 25

ESPECIFICACIONES

- 1) Archivador Movil metalico
Terminado color aluminio
- 2) Archivador Fijo metalico
Terminado color aluminio
- 3) Estructura Metalica
Terminado color aluminio
- 4) Riel metalico
- 5) Tablero de aglomerado es= 4cm
Laminado de dos caras color aluminio
Terminado de canto duro color aluminio
- 6) Sistema mecanico metalico
- 7) Divisores metalicas
Terminado color aluminio

AMt1

PROYECTO	
Reestructuración BEDE piso 8 y 2	
Departamento Financiero	
Proyectado	Proyectado
	Comprobado
	OT

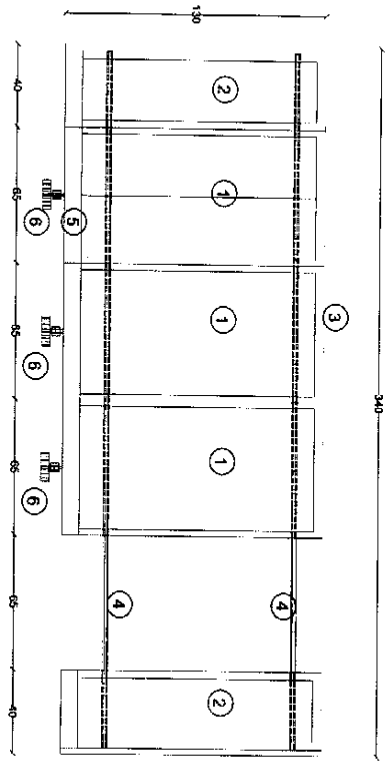

PLANTA ARCHIVADOR MOVIL

TIPO 01
BEDE MATRIZ
ESC 1:25

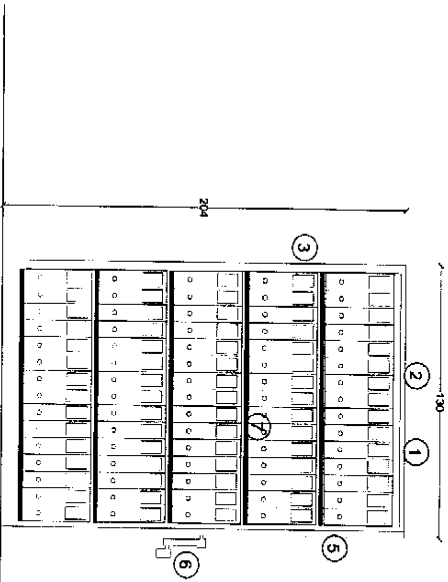

ELEVACION ARCHIVADOR MOVIL

TIPO 01
BEDE MATRIZ
ESC 1:25

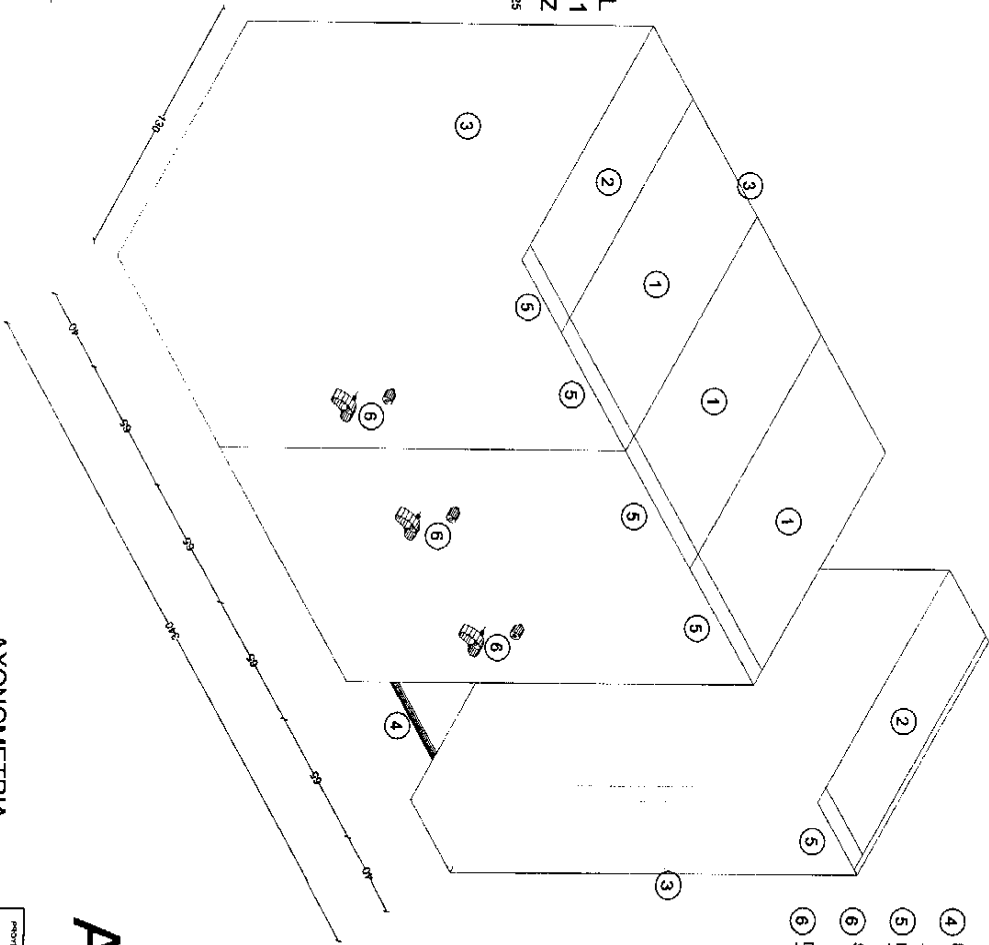

AXONOMETRIA

TIPO 01
BEDE MATRIZ
ESC 1:25

ESPECIFICACIONES

- 1 Archivador Movil metalico
Terminado color aluminio
- 2 Archivador Fijo metalico
Terminado color aluminio
- 3 Estructura Metalica
Terminado color aluminio
- 4 Riel metalico
- 5 Toldero de aglomerado 6-4cm
Laminado de dos caras color aluminio
Terminado de canto duro color aluminio
- 6 Divisores metalicas
Terminado color aluminio

AMT2

PROYECTO	
Reestructuración BEDE piso 3 y 2	
Departamento Financiero	
Participación	Financiera
	Operativa MIX

Handwritten signatures and initials.

