

# VERTEDERO DE EXCESOS

PLANTA  
ESC. 1:100

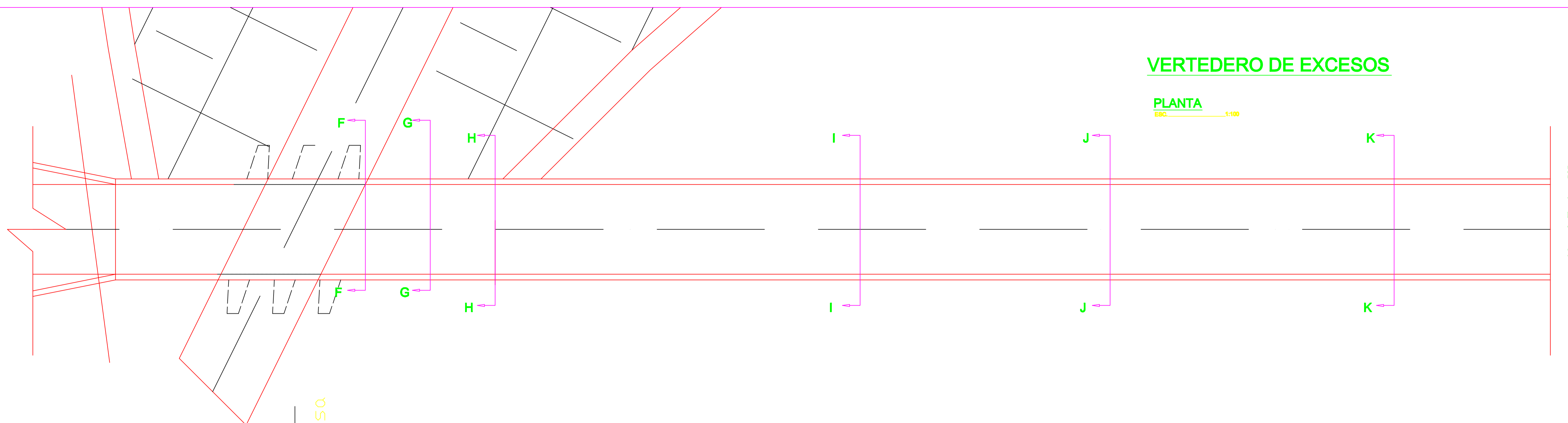

PERFIL LONGITUDINAL  
ESC. 1:100

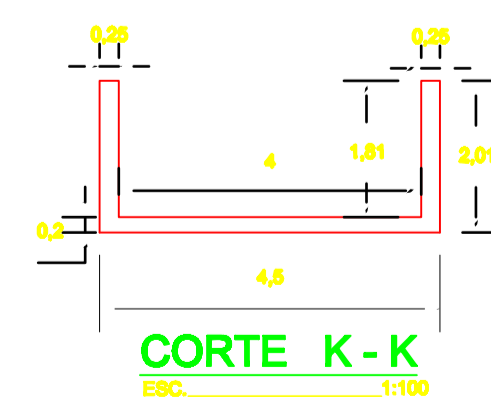
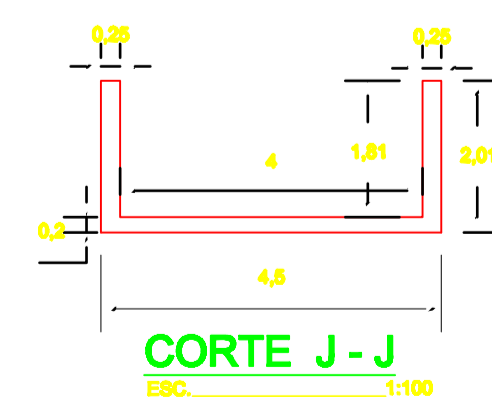
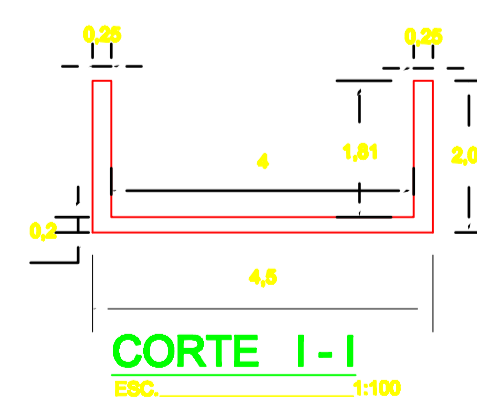
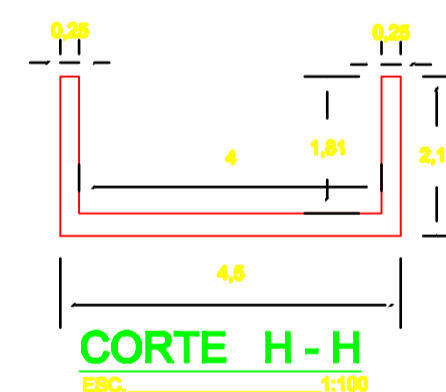
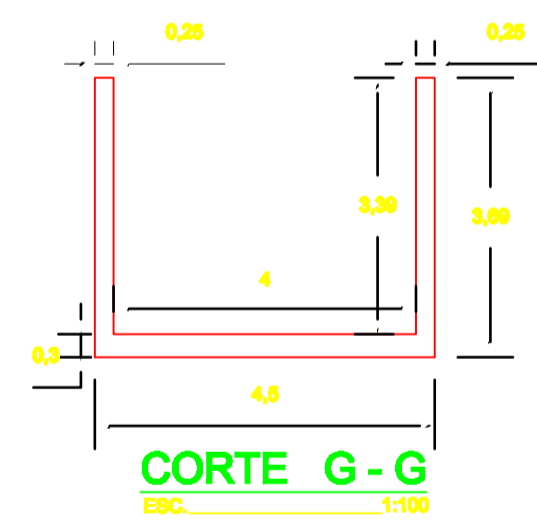
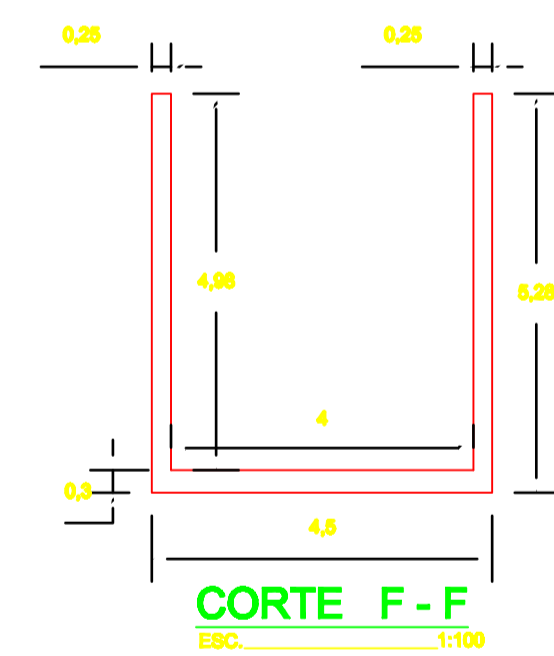
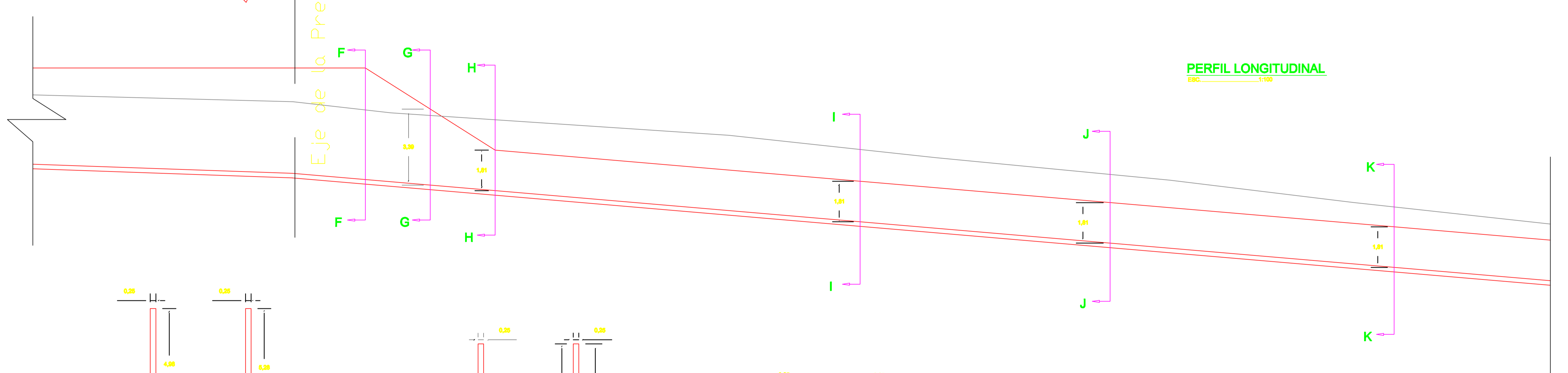

HONORABLE CONSEJO PROVINCIAL DEL AZUAY		ESTUDIOS A NIVEL DE DISEÑOS DEFINITIVOS	
CUNCA - ECUADOR		EMBALSE TASQUI	
ING. FELIPE CISNEROS E. Ph.D.		VERTEDERO Y RAPIDA	
		PLANTA, PERFIL Y CORTES DE G a K	
DISEÑO	LGZ	SUPERVISOR	
REVISOR	LGZ	APROBADO	
DIBUJO	IGR		
ESCALA:	INDICADA	FECHA:	AGOSTO, 2003
REFERENCIA:		PLANO N°:	TSQ-006

REV	FECHA	DESCRIPCION